

*Smart solutions, united experience*

# **MAMMOET** **Salvage**



## ***The Changing world of Salvage***

***Bas Coppes***  
***Commercial Manager***

[www.mammoetsalvage.com](http://www.mammoetsalvage.com)



*Smart solutions, united experience*



## ***Content presentation***

- **Introduction Mammoet Salvage**
- **How do we see salvage**
  - **Emergency Response**
  - **Wreck removal**
  - **Cargo recovery**
  - **Environmental Salvage**
- **Why do you need Global Salvor**



*Smart solutions, united experience*



## ***Mammoet Salvage***

- Division of Mammoet;
- Established in the beginning of 2006
- More than **200 years** experience in the salvage
- Tailor made innovative solutions
- Conventional salvage & wreck removal



## ***Introduction Mammoet***

- Market leader in heavy lifting and transport
- Innovative engineering, trend setting and record breaking
- Existence more than 45 years
  
- Local presence in virtually all parts of the world
- Locations; 89 in Europe, North and South America (including Canada), Asia, Middle East and South Africa
  
- Financial strong : turnover in excess of €600 million
- Employees : 3,200 worldwide
- Markets : Active both on-shore and off-shore in the markets Energy, petrochemical, power, nuclear, offshore and marine



*Smart solutions, united experience*



***Petrochemical industry    Lifting & Installation***



**Using cranes**



*Salvage ?*

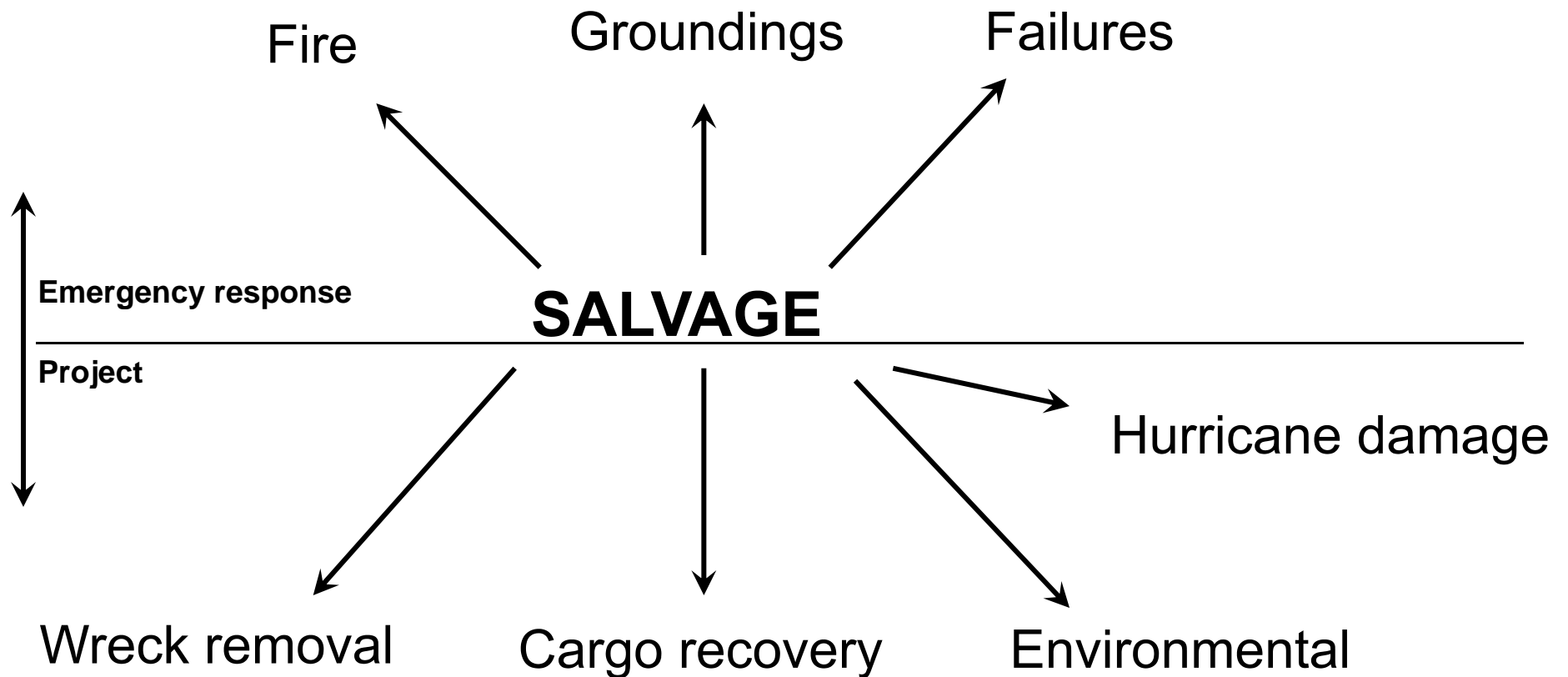

*Smart solutions, united experience*

 **MAMMOET**  
Salvage



***Emergency response vs Project approach***

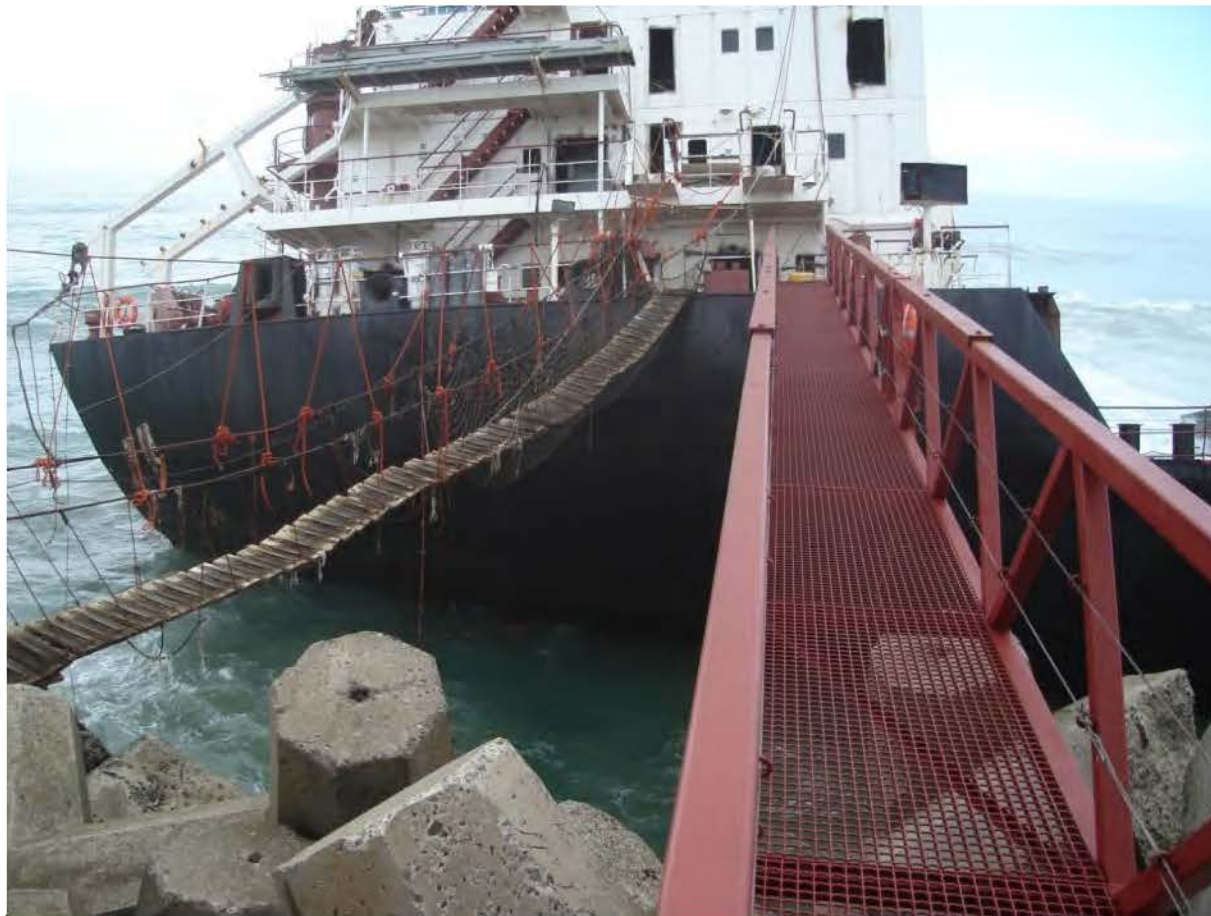

*Smart solutions, united experience*



***Case study, Emergency response, arrival on site***



**Malacca Strait  
Last August**



Smart solutions, united experience

# MAMMOET Salvage



## *Case study, Emergency response, the next morning*

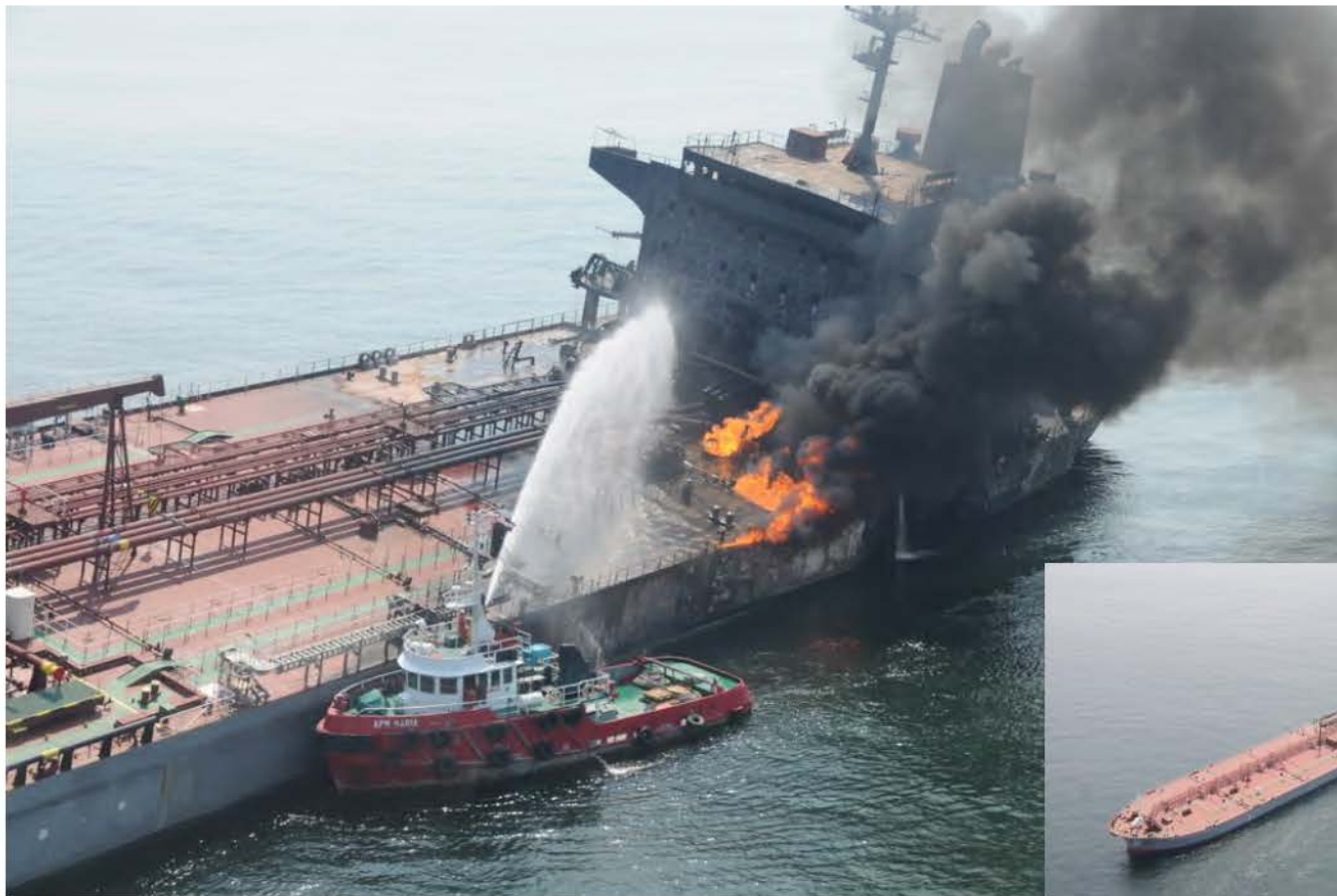

*Smart solutions, united experience*

# **MAMMOET** Salvage



## ***Case Study, Emergency response, fire under control***



Mammoet Salvage 05-Sept-2009

*Smart solutions, united experience*

# **MAMMOET** **Salvage**



***Case Study, Emergency response, transit to STS loc.***



Mammoet Salvage 05-Sept-2009

*Smart solutions, united experience*



## ***Case study, Emergency response, STS***





*Smart solutions, united experience*



## ***Emergency Response***

**Contract form :**

**-Lloyd open form**

**-SCOPIC**

**-Commercial terms with bonus structure**

**Trend:**

**Number of LOF's slightly declining but value increasing**

*Smart solutions, united experience*

 **MAMMOET**  
Salvage



***When emergency response fails***



*Smart solutions, united experience*

 **MAMMOET**  
Salvage



***When emergency response fails***



*Smart solutions, united experience*

 **MAMMOET**  
**Salvage**



***Case study, Wreck removal, The Engineering***

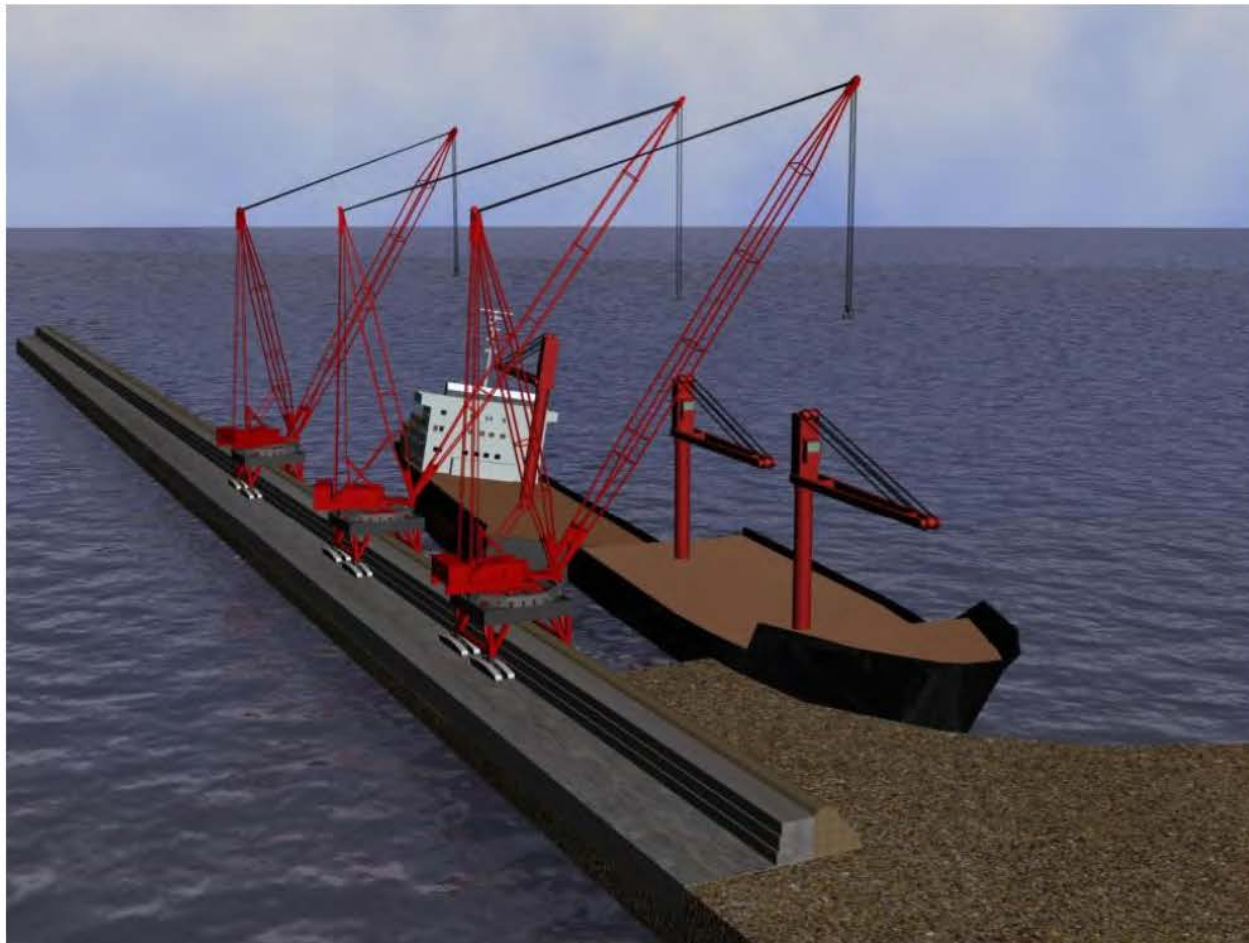



*Smart solutions, united experience*

 **MAMMOET**  
**Salvage**



## ***Case Study, Wreck removal, The Chainpullers***



*Smart solutions, united experience*

# **MAMMOET** Salvage



## ***Case Study, Wreck removal, project execution***



*Smart solutions, united experience*

# **MAMMOET** Salvage



## ***Case Study, Wreck removal***





## ***Case Study, Wreck removal***

### **Contract:**

- Wreck hire
- Wreck stage
- Wreck fix
- Government contracts

### **Trend:**

**More complex wreck removals due to technical developments & port clearance projects**



# Case Study, Cargo Recovery

## Cargo recovery aluminum T-bars, Gulf of Finland

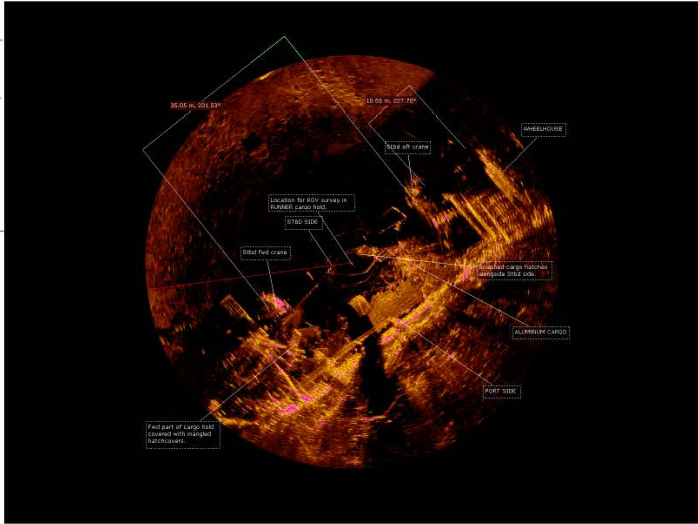
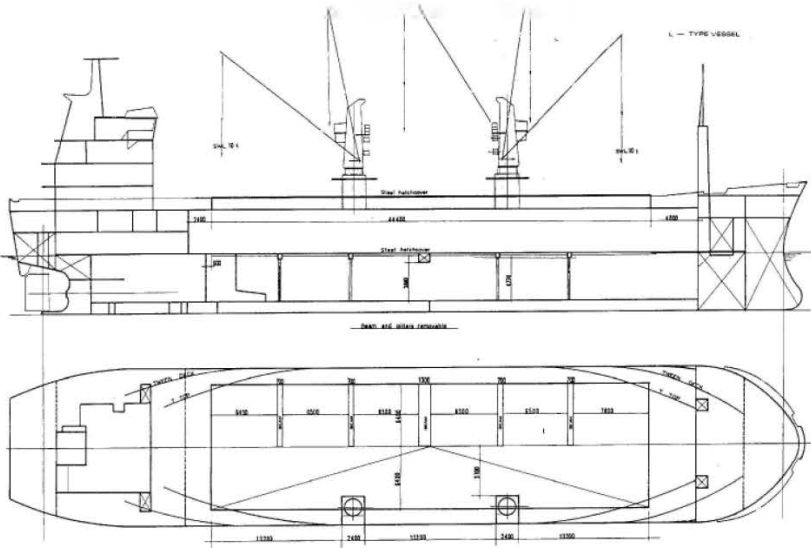

Smart solutions, united experience



## Case Study, Cargo recovery

Cargo recovery aluminum T-bars, Gulf of Finland



Smart solutions, united experience

# MAMMOET Salvage



## Case Study, Cargo recovery



*Smart solutions, united experience*

 **MAMMOET**  
Salvage



## ***Case Study, Cargo recovery***

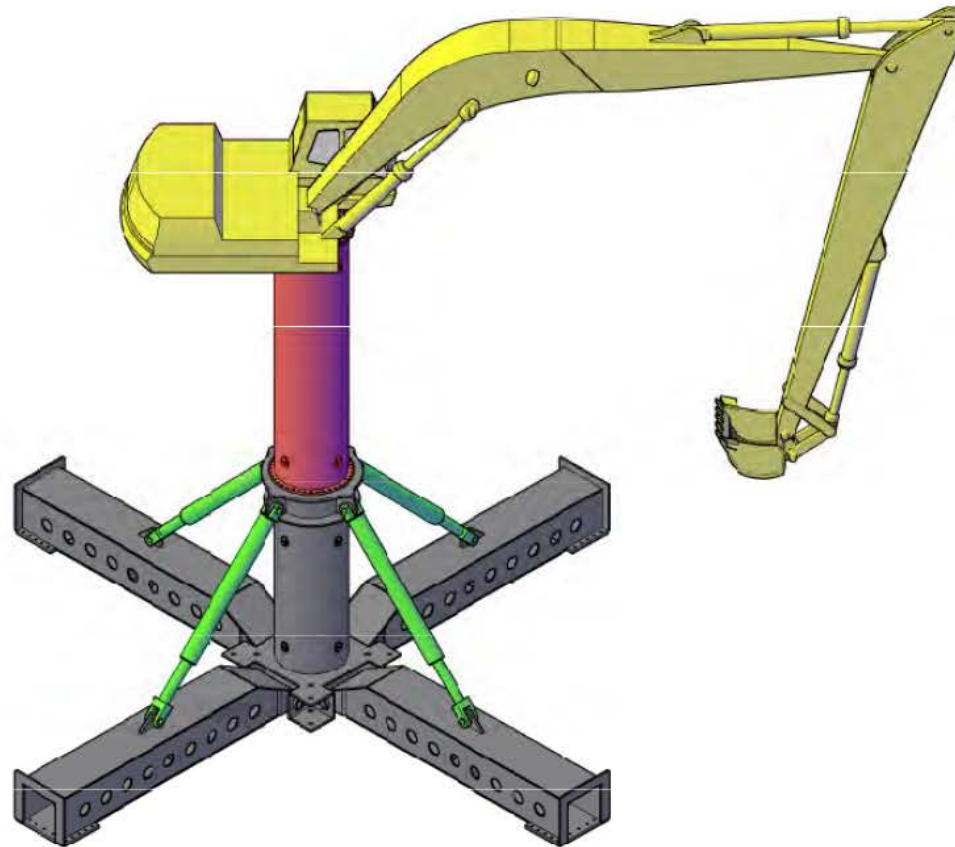



Smart solutions, united experience



## Case Study, Cargo recovery

Cargo recovery aluminum T-bars,  
Gulf of Finland

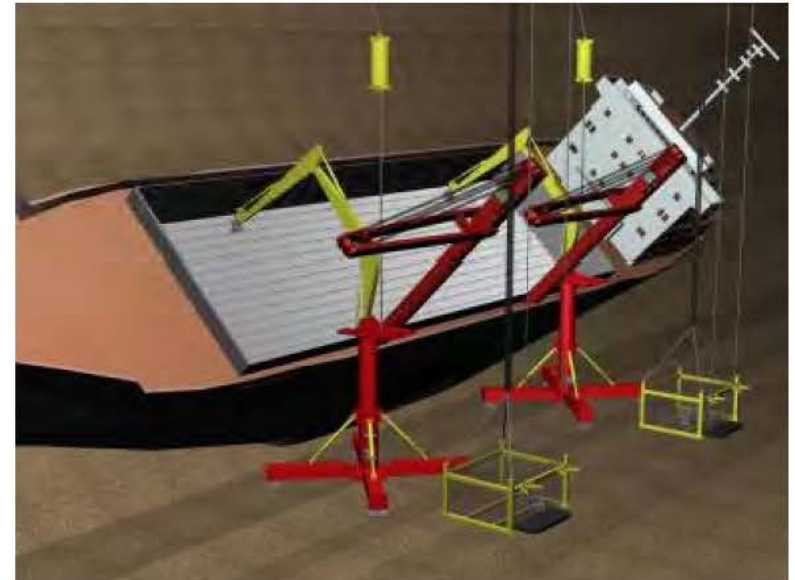
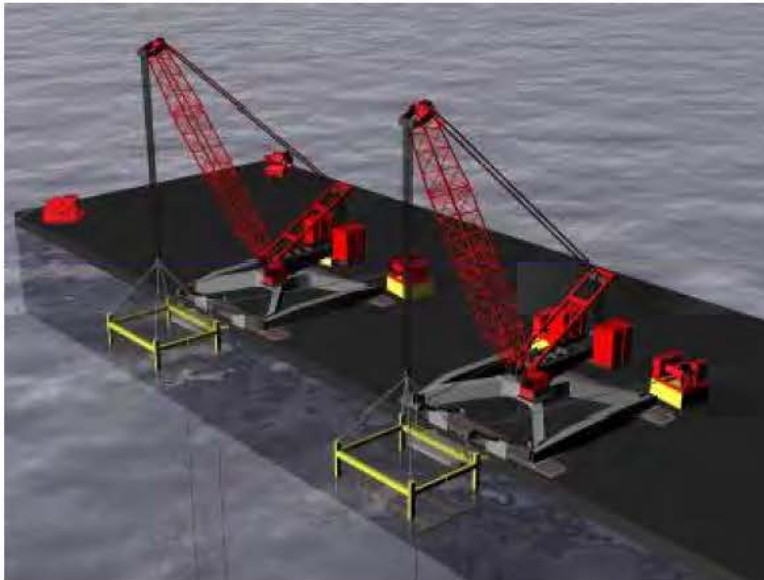

Smart solutions, united experience

# MAMMOET Salvage



## Case Study, Cargo recovery



*Smart solutions, united experience*



## ***Case Study, Cargo recovery***





## ***Case Study, Cargo Recovery***

### **Contract:**

- Contract based on value of recovered cargo
- Wreck hire
- Wreck stage
- Wreck fix

### **Trend:**

**Highly dependable on commodity value and new technical limits**

*Smart solutions, united experience*



## ***Case Study, Environmental salvage***



Smart solutions, united experience



## Case Study, Environmental salvage



On 24 August 2007 one of the transport barges developed a list and lost its cargo in the Robson Bight Ecological Reserve. Major concern of this incident was a tanker truck, carrying 10,000 liters of diesel oil.



## Case study – Environmental salvage



Robson Bight

Robson Bight is a small bay on the east coast of British Columbia's Vancouver Island.

It is one of the most significant killer whale habitats in the world.

Since 1982 it is an ecological reserve, closed to the public in order to protect the whales.



## ***Case Study, Environmental salvage***

- Ministry of Environment
  - Canadian Coastguard
  - Fishery and Oceans
  - Dept - Mammals
  - Dept - Juvenile Salmon
  - Dept - Migrating birds
  - Dept - Shell fish
  - Transport Canada
  - Oil pollution fund
  - Government of BC
  - Local tourist industry (Whale watching)
  - Unions
  - Work safe BC
  - Four first nation (Indian) tribes
  - Local municipalities
  - Local environmental groups
  - Green peace
  - Living Oceans
  - Media
- Etc.



*Smart solutions, united experience*



## ***Case Study – Environmental salvage***



**Truck found upright at a water depth of 1200 feet.**



# MAMMOET Salvage



## Case Study, Environmental salvage

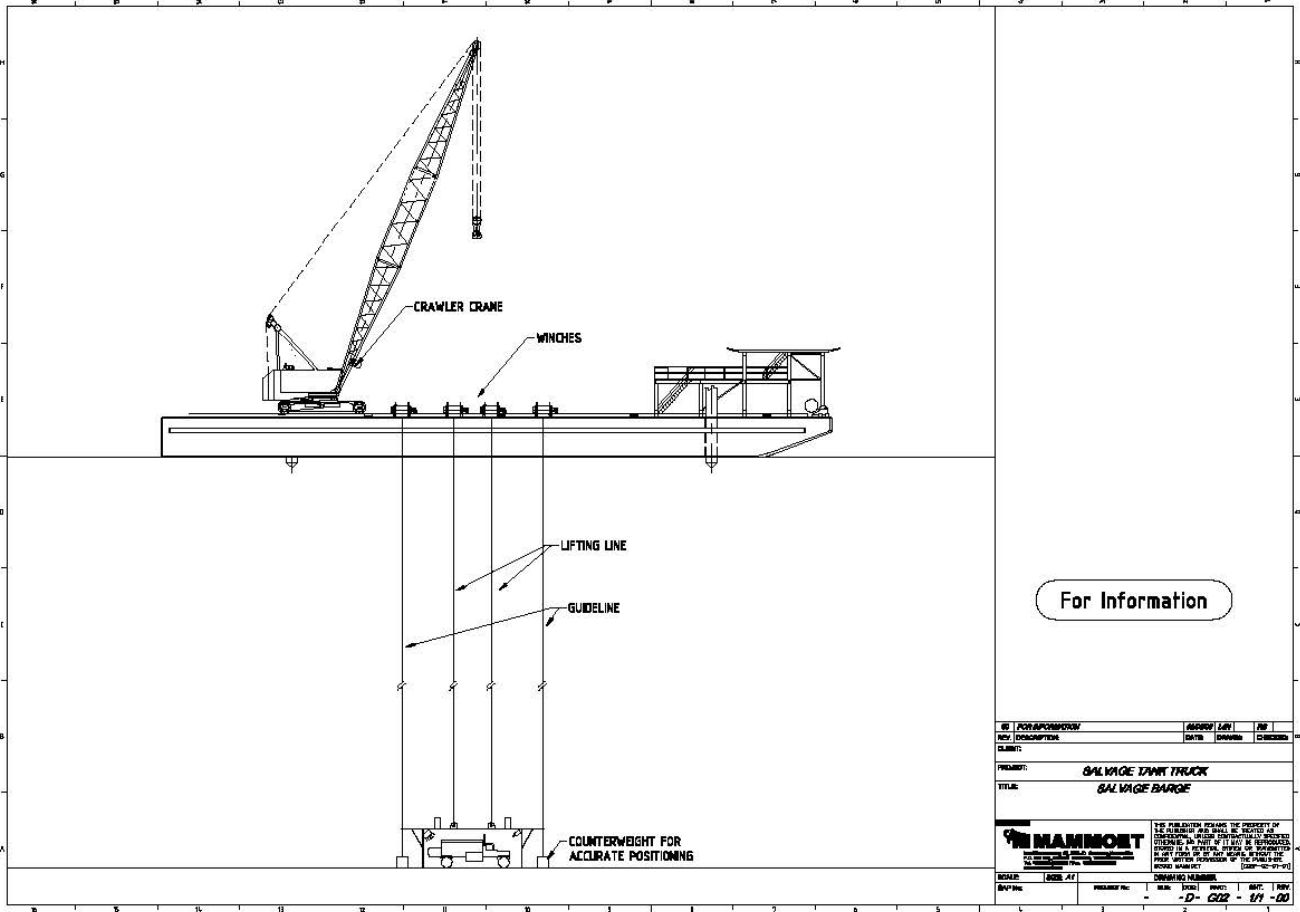

# MAMMOET Salvage



## Case Study, Environmental salvage

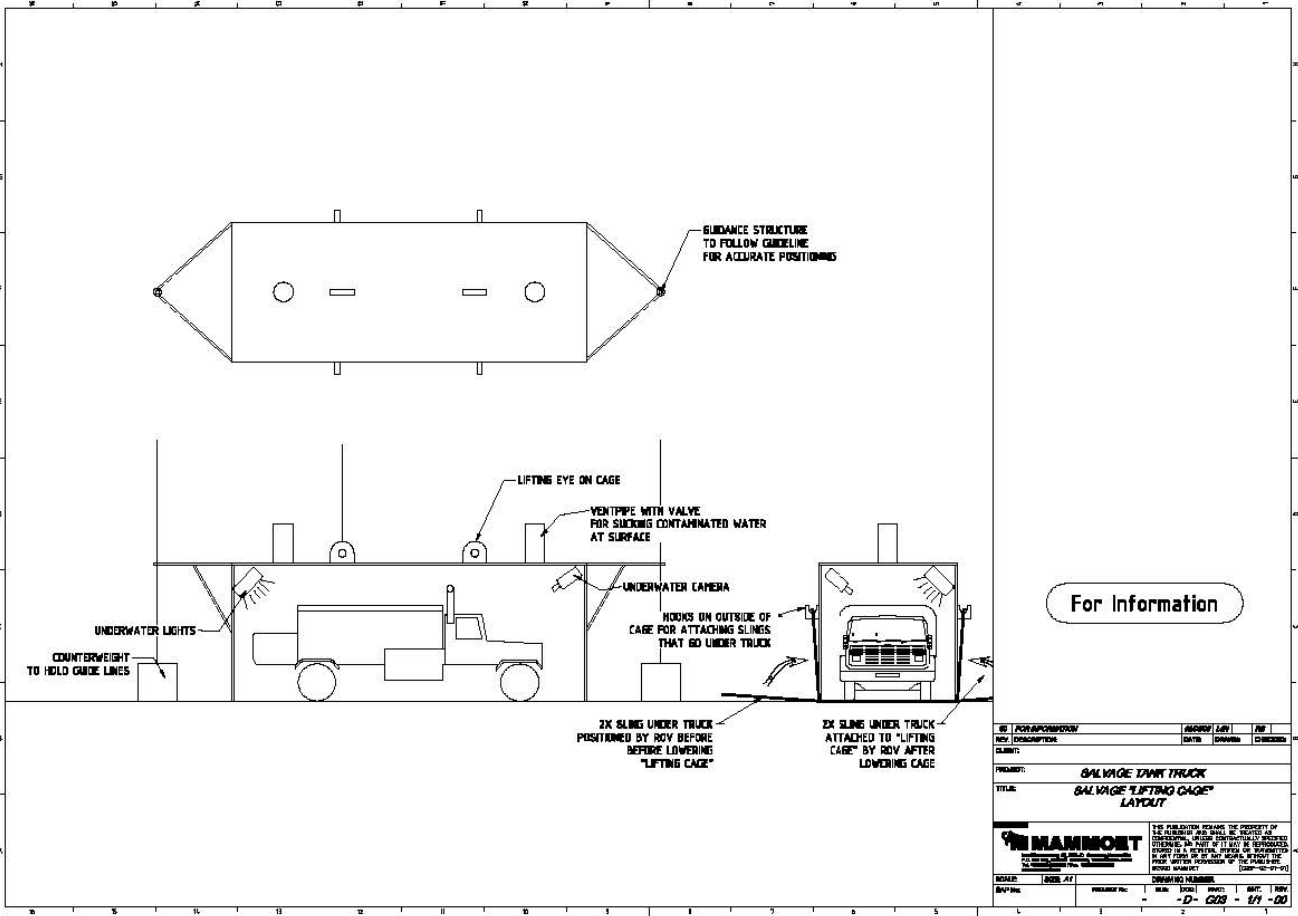

Smart solutions, united experience



## Case Study, Environmental salvage



Construction of DWRC at the Mammoet facilities in Canada



Smart solutions, united experience



## Case Study, Environmental salvage, Testing



Full scale testing of equipment constructed.



Smart solutions, united experience

# MAMMOET Salvage



## Case Study, Environmental salvage

### Fuel truck recovery 1200 ft, Vancouver Canada



*Smart solutions, united experience*



## ***Case Study, Environmental salvage***



**Operations all remote controlled and performed without the engagement of divers.**

Smart solutions, united experience



## Case Study, Environmental salvage

Fuel truck recovery 360 meter, Vancouver Canada





Smart solutions, united experience



## ***Case Study, Environmental salvage***



**Truck safely recovered and placed on board the barge, within an environmental barrier in order to avoid damage to the environment by leaking contaminants from the truck.**

*Smart solutions, united experience*



## *Case Study, Environmental salvage*



**Verifying theory and practice ...**



*Smart solutions, united experience*



## ***Case Study, Environmental salvage***

Full scale oil spill response equipment on direct stand by in order to combat any oil escaping during operations.



*Smart solutions, united experience*

 **MAMMOET**  
**Salvage**



## ***Case Study, Environmental salvage***





*Smart solutions, united experience*



## ***Case Study, Environmental Salvage***

### **Contract:**

- Taylor made contract with bonus incentives
- Wreck hire
- Wreck stage
- Wreck fix

### **Trend:**

**Increase due to public awareness & politics, huge market**



*Smart solutions, united experience*



## ***Why do you need a Global Salvor ?***

- **Operational :**  
The right people & the know how
- **Network:**  
Access to the right resources
- **Political:**  
Deal with the local problem



*Smart solutions, united experience*



**Mammoet Salvage**

**Smart solutions, united experience**



**Worldwide salvage 24/7**



***Thank you for your attention***